

Systems Protector

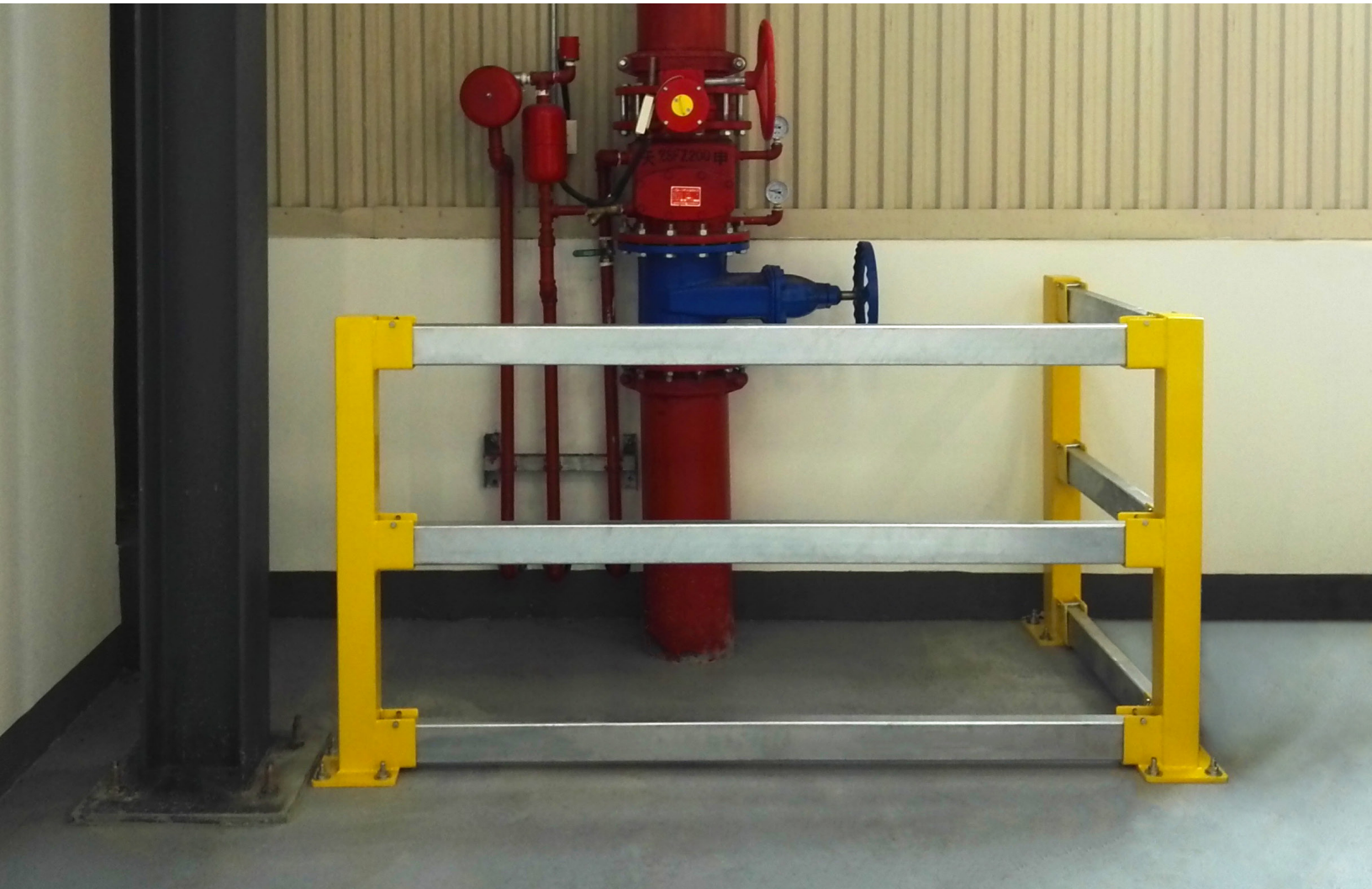

Protects essential systems while maintaining accessibility.

Are you tired of runaway pallets, stock carts and forklifts banging up the electrical, plumbing, refrigeration and information systems that are critical to keeping your business running? CartStop Systems Protector provides reliable protection from damaging blows, saving you money on costly repairs, while allowing full access to your systems when needed.

Tough Heavy-duty steel construction with safety yellow powder coat finish is impact resistant to warehouse equipment

Shock Absorbing Steel cross members safely protect critical systems, yet can be easily removed to allow access for maintenance and service

Speedy Install Self-threading concrete anchors eliminate the need for messy adhesives or quick-set cement

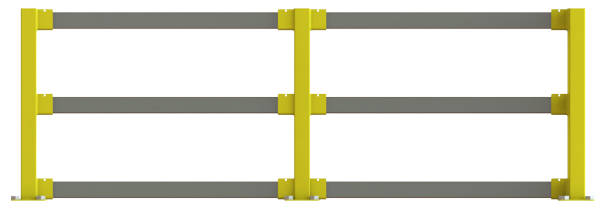

Systems Protector

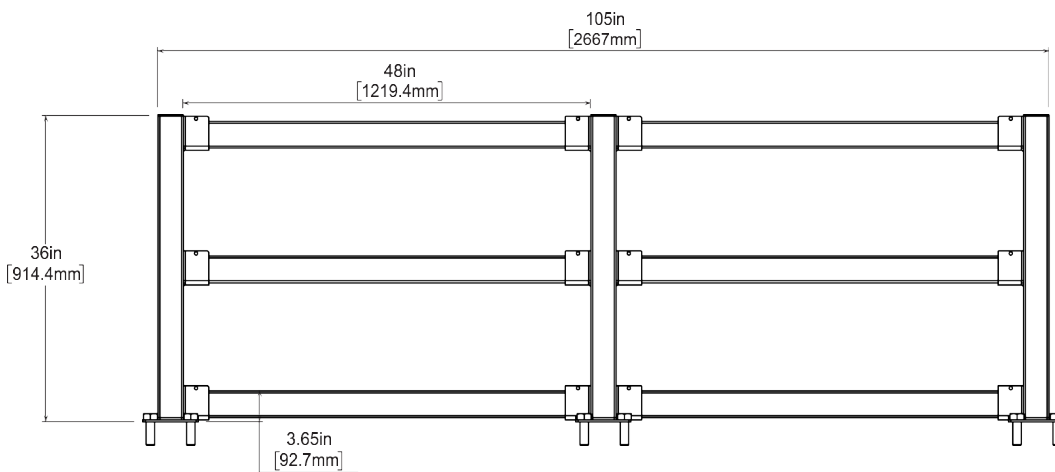
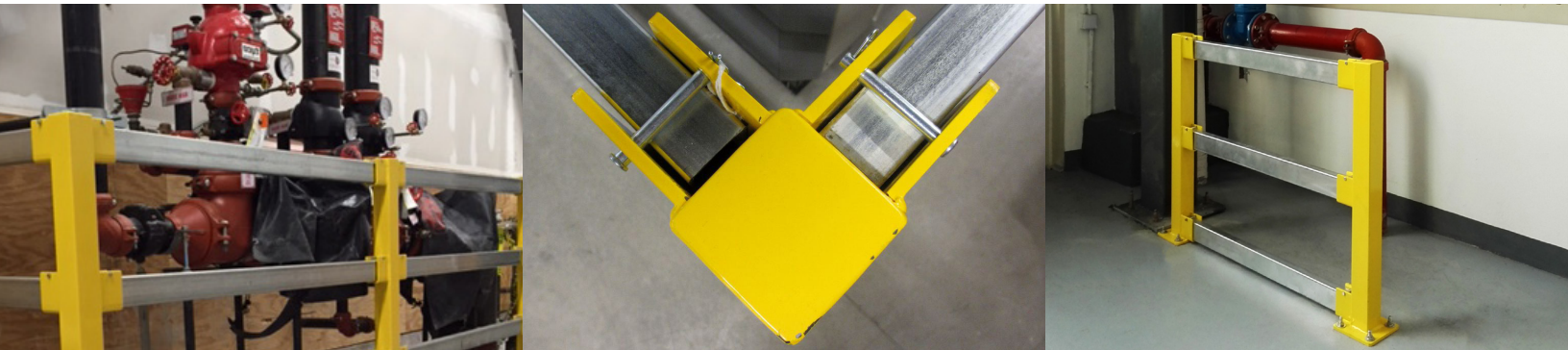

Steel cross members safely protect critical systems, yet easily removed to allow access for maintenance



36" Uprights Components:

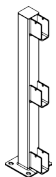

End

Hardware included—all uprights ship with concrete anchors

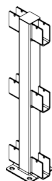

Middle

Hardware included—all uprights ship with concrete anchors

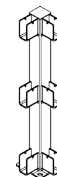

Corner

Hardware included—all uprights ship with concrete anchors

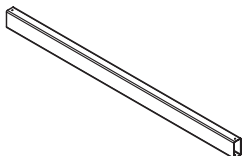

Box Rail 8' Length

Electroplated Cold Rolled Steel



5/8 inch Concrete Anchor

3 inches long, self threading, & with anti-rotation serrations to prevent back-out

Red Head 5/8" x 3" LDT

Safety Yellow

Standard Colors – 2 week lead for quantity 1-10. Inquire for quantities 11 or more.



McCue Corporation
Peabody, MA 01960, USA
+1 (800) 800 8503
customer@McCue.com

McCue UK & Europe
Milton Keynes, United Kingdom
+44 (0)1908 365 511
uksales@McCue.com

McCue Asia
迈客(厦门)有限公司
Xiamen, Fujian, China
+86-592-2200790

mccue.com

